

## **LMI-BASED FEEDBACK SUPPRESSION OF EXTERNAL DISTURBANCES FOR THE RUAV**

### **Introduction**

Development of rotorcraft-based unmanned aerial vehicles (RUAV) is one of the priorities in aircraft industry nowadays. Unlike fixed-wing aircrafts, helicopters can describe vertical flight trajectories, including hovering and vertical take-off and landing (VTOL). Due to their versatile maneuverability they can be widely used in different spheres for numerous practical tasks realization. Application of RUAV allows avoidance of any risks for the crew in extreme and dangerous conditions at comparatively low costs for their maintenance and exploitation.

Suppression of atmospheric disturbance acting the RUAV (stochastic turbulent wind, discrete wind gusts, etc.) is extremely important to perform given tasks ordered by the ground-based command station via wireless communication with high quality and efficiency.

In modern rotorcrafts this problem is usually solved with the help of stability and controllability augmentation system (SCAS) design [1–5]. One of the effective methods of robust control theory of SCAS synthesis by static output feedback (SOF) is the Linear Matrix Inequalities (LMI) method [1-4, 6-8].

### **Statement of the Problem**

In this paper SOF control (fig. 1) is applied to the Berkeley RUAV [9] stabilization in the hovering flight taking into account the actuators dynamics and accelerometers incorporation into the measurement unit of the flight control system.

The algorithm of the SOF controller design and its gain matrix  $K$  determination is implemented by LMI method and includes three main stages [1–3]:

I. LMI-based linear-quadratic (LQ) problem solution and stabilizing controller synthesis including the procedure of the feedback matrix  $K$  spectral norm restriction in agreement with the constraint (1) [1–4, 6–7]:

$$\left\| H_{zw}^C(s, K) \right\|_{\infty} < \gamma, \quad (1)$$

where  $H_{zw}^C(s, K)$  – matrix of transfer functions (TF) which describes the relationship between the input exogenous disturbance  $w$  and output vector  $z$  of the closed-loop system,  $\|\cdot\|_\infty$  –  $H_\infty$ -norm,  $\gamma$  – scalar which represents the degree of exogenous disturbance suppression.

II. Inverse LQ problem solution for  $K$  and determination of weighting matrices  $Q, R, N$  of the quadratic functional  $J$  [1–4]:

$$J = \int_0^\infty \begin{bmatrix} \mathbf{x}^T & \mathbf{u}^T \end{bmatrix} \begin{bmatrix} \mathbf{Q} & \mathbf{N} \\ \mathbf{N}^T & \mathbf{R} \end{bmatrix} \begin{bmatrix} \mathbf{x} \\ \mathbf{u} \end{bmatrix} dt. \quad (2)$$

III.  $H_2$ –optimization of the SCAS by the SOF loop shaping.

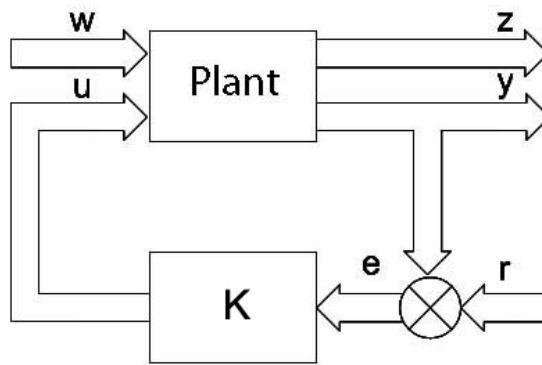

Fig. 1. Block diagram of the SCAS

Plant – control object,  $K$  – SOF controller,  $w$  – vector of exogenous disturbance,

$u$  – control vector,  $z$  – output vector which is used to evaluate the closed-loop system performance,  $y$  – output vector which is used for SOF loop shaping,  $e$  – error,  $r$  – reference signal.

### System Description

In this paper linear time-invariant (LTI) multi-input multi-output (MIMO) model of Berkeley RUAV which is valid for hovering is considered [9].

A 6-degrees-of-freedom linear rigid body rotorcraft model is augmented with the first-order approximation of servomotor or Bell-Hiller Stabilizer (BHS) system dynamics [10] which modifies the RUAV dynamics significantly and has a pair of paddle-shaped blades that are connected to the main blades by a series of mechanical linkages. Currently, almost all model-scale helicopters are equipped with a BHS, a mechanical blade pitch control system that improves helicopter stability. From a control point of view, the stabilizing bar can be interpreted as a dynamic feedback system for the roll and pitch rates. The BHS improves stability characteristics of the RUAV. The most important role of the

servomotor is to slow down the roll and pitch response so that human pilot on the ground can control the small RUAV with the remote controller [9, 10].

The peculiarity of the LTI MIMO model of the RUAV is the absence of its separation on the model of longitudinal and lateral motion which is especially justified for hover.

The set of differential equations describing dynamics of the system in time-domain is represented by (3):

$$\begin{cases} \dot{x} = Ax + B_u u + B_w w, \\ y = C_y x + D_{yu} u + D_{yw} w, \\ z = C_z x + D_{zu} u + D_{zw} w, \end{cases} \quad (3)$$

where  $x \in R^{11 \times 1}$  – state vector;  $u \in R^{4 \times 1}$  – control vector;  $y \in R^{11 \times 1}$  – output vector;  $w \in R^{3 \times 1}$  – vector of atmospheric disturbance which affects the RUAV in horizontal and vertical plane (by three axes);  $z \in R^{3 \times 1}$  – output vector which is used to evaluate the closed-loop system performance;  $A \in R^{11 \times 11}$ ,  $B_u \in R^{11 \times 4}$ ,  $B_w \in R^{11 \times 3}$ ,  $C_y \in R^{11 \times 11}$ ,  $D_{yu} \in R^{11 \times 4}$ ,  $D_{yw} \in R^{11 \times 3}$ ,  $C_z \in R^{3 \times 11}$ ,  $D_{zu} \in R^{3 \times 4}$ ,  $D_{zw} \in R^{3 \times 3}$  – matrices which describe RUAV state-space model. Numerical values of these matrices are given in the example below.

State vector of the RUAV includes the following components [9]:

$$x = [u \quad v \quad p \quad q \quad \varphi \quad \theta \quad a_s \quad b_s \quad w \quad r \quad r_{fb}]^T,$$

here  $u, v, w$  – body-fixed linear longitudinal, lateral and vertical velocity respectively;  $\theta, \varphi$  – pitch and roll angle respectively;  $q, p, r$  – pitch, roll and yaw rate respectively;  $a_s, b_s$  – BHS flapping angles;  $r_{fb}$  – feedback gyro sensor state.

Control vector consists of four components [9]:

$$u = [u_{as} \quad u_{bs} \quad u_{\theta} \quad u_{r_{fb}}]^T,$$

where  $u_{as}, u_{bs}$  – main rotor and flybar cyclic inputs,  $u_{\theta}$  – main rotor collective input,  $u_{r_{fb}}$  – tail rotor collective input.

$$z = [a_x \quad a_y \quad a_z]^T,$$

here  $a_x = \frac{du}{dt}$ ;  $a_y = \frac{dv}{dt}$ ;  $a_z = \frac{dw}{dt}$  – longitudinal, lateral and vertical acceleration respectively.

## I. LMI-based LQ problem solution

On this stage it is necessary to design stabilizing “minimal controller”  $K$  which guarantees the constraint (1) for the system (3) at the state vector  $x$

complete measurement. Minimal controller denotes additional requirement to the gain matrix  $K$  spectral norm minimization.

Feedback controller's spectral norms restriction allows restriction of the matrix  $K$  coefficients that is very important to avoid or at less to diminish probability of the actuator saturation [11].

The matrix of TF which describes the relationship between the input exogenous disturbance  $w$  and output vector  $z$  of the closed-loop system is determined by the formula:

$$H_{zw}^C(s, K) = [C_z + D_{zu}K](Is - A - B_uK)^{-1}B_w + D_{zw}.$$

LMI-based determination of the feedback matrix  $K$  is implemented with the next formula:

$$K = YQ^{-1}.$$

In general this problem is reduced to the standard LMI Eigenvalue problem [6] and a set of inequalities solution:

$$\begin{bmatrix} Z & Y \\ Y^T & Q \end{bmatrix} > 0,$$

$$Z < \lambda I, \begin{bmatrix} A_c Q + Q A_c^T + B_c Y + Y^T B_c^T + B_w R B_w^T & L \\ L^T & -N^{-1} \end{bmatrix} \leq 0, \quad Q > 0,$$

$$A_c = (A + B_u K) + B_w R D_{zw}^T C_z, \quad B_c = B_u + B_w R D_{zw}^T D_{zu}, \quad I - \text{eye matrix}$$

$$L = Q C_z^T + Y^T D_{zu}, \quad N = I + D_{zw} R D_{zw}^T, \quad R = (\gamma^2 I - D_{zw}^T D_{zw})^{-1}.$$

To solve this problem in MATLAB environment the procedure *gevp* is used [7] for the given value  $\gamma$  (1).

## II. Inverse LQ problem solution

On this stage it is necessary to solve inverse LQ problem for the designed on the previous stage controller  $K$  using the algorithm given in [1–3].

Dynamics of the system is described with the set of equations (3),  $x(0) \neq 0$ . State matrix  $A$ , control matrix  $B = [B_w \ B_u]$  and feedback gain coefficient matrix  $K$  which satisfy the restriction  $\text{Re } \lambda(A + BK) < 0$  are given. It is necessary to determine weighting matrices  $Q, R, N$  of the quadratic functional  $J$  (2).

LMI-based algorithm of the inverse LQ problem solution includes the procedure of the scalar  $\lambda$  minimization at the next inequalities performance [2-3]:

$$(A + BK)^T P + P(A + BK) + K^T R K + N K + K^T N^T \leq 0, \quad (4)$$

$$\begin{bmatrix} Y & S \\ S^T & I \end{bmatrix} > 0, \quad Y < \lambda I, \quad S = B^T P + R K + N^T. \quad (5)$$

Thus matrices P, R, N, Y and corresponding value of the scalar  $\lambda$  are determined as the result of inequalities (4), (5) solution.

The procedure *gevp* is used to solve this problem in MATLAB environment [7].

Matrix Q is determined as the result of the equation (13) solution [1–4]:

$$(A + BK)^T P + P(A + BK) + K^T R K + NK + K^T N^T = -Q.$$

### III. $H_2$ -optimization of the SCAS by the SOF loop shaping.

Likewise to [1–3] optimization task on this stage is:

$$\min_{K, \mu} J, \quad J = E \left\{ \int_0^{\infty} \begin{bmatrix} x^T & u^T \end{bmatrix} \begin{bmatrix} Q & N \\ N^T & R \end{bmatrix} \begin{bmatrix} x \\ u \end{bmatrix} dt \right\} + r\mu^2, \quad (6)$$

where  $\mu$  – scalar which provides stability of the system:  $A_{\mu} = A + \mu I$ ,  $\text{Re}(\lambda_{A_{\mu}}(A_{\mu})) < 0$ ,  $\lambda_{A_{\mu}}$  – eigenvalues of the stable state matrix  $A_{\mu}$ ;  $r$  – coefficient.

Scalar  $\mu$  is also an additional optimization parameter together with the matrix K.

Control law for the system (3) is represented with the equation (7):

$$u = Ky, \quad (7)$$

where  $y$  – output vector which is used for SOF loop shaping, K – gain coefficients matrix of the stabilizing controller.

As the result of the optimization task (6) solution the matrix of optimal gain coefficients of stabilizing SOF controller K can be determined.

### Case Study

Efficiency of the introduced LMI-based algorithm of SCAS for BIBO exogenous disturbance suppression is demonstrated for the Berkeley RUAV [9] stabilization in the hovering flight taking into account the actuators dynamics and accelerometers incorporation into the measurement unit of the flight control system. The dynamic model of a single main rotor and tail rotor helicopter equipped with a Bell-Hiller or Hiller stabilizing bar [10] which can be interpreted as a dynamic feedback system for the roll and pitch rates.

As it was already mentioned above the most important peculiarity of the LTI MIMO model of the RUAV is the absence of its separation on the model of longitudinal and lateral motion which is especially justified for hover. One deficiency of the given in [9] state-space model is the absence of the cross-coupling from yaw to sideslip and roll.

Numerical values of the state-space matrices of the MIMO model (3) for the Berkeley RUAV are given in [9]:

$$\mathbf{A} = \begin{bmatrix} -0.0629 & 0 & 0 & 0 & 0 & -g & -g & 0 & 0 & 0 & 0 \\ 0 & 0.0305 & 0 & 0 & g & 0 & 0 & g & 0 & 0 & 0 \\ 0.2978 & -0.7061 & 0 & 0 & 0 & 0 & 40.361 & 237.42 & 0 & 0 & 0 \\ 1.3057 & -1.2199 & 0 & 0 & 0 & 0 & 220.18 & -11.438 & 0 & 0 & 0 \\ 0 & 0 & 1 & 0 & 0 & 0 & 0 & 0 & 0 & 0 & 0 \\ 0 & 0 & 0 & 1 & 0 & 0 & 0 & 0 & 0 & 0 & 0 \\ 0 & 0 & 0 & -1 & 0 & 0 & -4.3459 & 1.4487 & 0 & 0 & 0 \\ 0 & 0 & -1 & 0 & 0 & 0 & -1.5915 & -4.3459 & 0 & 0 & 0 \\ 0 & 0 & 0 & 0 & 0 & 0 & -3.0523 & -15.063 & -1.3453 & 0.2222 & 0 \\ 0 & 0 & -0.0178 & 0 & 0 & 0 & 0 & 0 & 1.1860 & -2.9986 & -22.126 \\ 0 & 0 & 0 & 0 & 0 & 0 & 0 & 0 & 0 & 3.1541 & -9.5035 \end{bmatrix};$$

$$\mathbf{B}_u = \begin{bmatrix} 0 & 0 & 0 & 0 \\ 0 & 0 & 0 & 0 \\ 0 & 0 & 0 & 0 \\ 0 & 0 & 0 & 0 \\ 0 & 0 & 0 & 0 \\ 0.5259 & 2.1922 & 0 & 0 \\ 2.2333 & -0.0917 & 0 & 0 \\ 0 & 0 & 10.6446 & 0 \\ 0 & 0 & 4.4911 & -103.335 \\ 0 & 0 & 0 & 0 \end{bmatrix}; \mathbf{C}_y = \begin{bmatrix} \mathbf{A}(1,:) \\ \mathbf{A}(2,:) \\ \mathbf{O}_{6 \times 2}, \mathbf{I}_{6 \times 6}, \mathbf{O}_{6 \times 3} \\ \mathbf{A}(9,:) \\ \mathbf{O}_{2 \times 9}, \mathbf{I}_{2 \times 2} \end{bmatrix};$$

$$\mathbf{B}_w = [-\mathbf{A}(:,1) \quad -\mathbf{A}(:,2) \quad -\mathbf{A}(:,9)];$$

$$\mathbf{D}_{yw} = [\mathbf{B}_w(1,:); \mathbf{B}_w(2,:); \mathbf{O}_{6 \times 3}; \mathbf{B}_w(9,:); \mathbf{O}_{2 \times 3}];$$

$$\mathbf{C}_z = [\mathbf{A}(1,:); \mathbf{A}(2,:); \mathbf{A}(9,:)]; \mathbf{D}_{zw} = [\mathbf{B}_w(1,:); \mathbf{B}_w(2,:); \mathbf{B}_w(9,:)];$$

here  $X(m,:)$  – row of a matrix  $X$ ,  $m$  – ordinal number of the row;  $X(:,n)$  – column of a matrix  $X$ ,  $n$  – ordinal number of the column;  $\mathbf{O}_{i \times j}$ ,  $\mathbf{I}_{r \times r}$  – zeros and eye matrix of dimension  $i \times j$  and  $r \times r$  respectively.

Taking into account accelerometers data  $a_x, a_y, a_z$  the output vector is:

$$\mathbf{y} = [a_x \quad a_y \quad p \quad q \quad \varphi \quad \theta \quad a_s \quad b_s \quad a_z \quad r \quad r_{fb}]^T.$$

Scalar  $\gamma$  (1) which shows the degree of atmospheric disturbance suppression limiting the matrix of TF  $H_{zw}^C(s, K)$  is set:  $\gamma = 1,5$ .

On the first stage feedback gain coefficient matrix  $K \in R^{4 \times 11}$  of the minimal controller is determined. Its spectral norm equals  $\|K\|_s = 0,1645$ .

As the result of the inverse LQ problem solution weighting matrices of the quadratic functional  $J$  (2) are calculated. Their dimensions are:  $Q \in R^{11 \times 11}$ ,  $R \in R^{4 \times 4}$ ,  $N \in R^{1 \times 4}$ .

Coefficient  $r$  is set:  $r = 10^{-6}$ .

As the result of  $H_2$ -optimization of the SCAS by the SOF loop shaping optimal gain coefficients matrix  $K \in R^{4 \times 11}$  of the SOF controller is determined. Its spectral norm:  $\|K\|_s = 0,0221$ .

$H_2$ -optimal SOF controller  $K \in R^{4 \times 11}$  satisfies the restriction (1):

$$\left\| H_{zw}^C(s, K) \right\|_{\infty} = 1.355 < \gamma.$$

Performance index (6) for the designed closed-loop SCAS including  $H_2$ -optimal SOF controller equals:  $J = 2.865$ .

Scalar  $\mu = 1.2131 \times 10^{-5}$ .

### **Simulation of the designed SCAS**

Simulation of the SCAS (fig. 1) was fulfilled in Simulink environment at atmospheric disturbances which affect control system in real conditions. Standard Discrete Wind Gust Model (Aerospace Blockset, Simulink) was used to simulate discrete wind gusts acting the RUAV in hover in horizontal an vertical plane accordingly to the USA standard MIL-F-8785C.

Numerical values which characterize simulated wind gusts are the next:

- 1) along the longitudinal axis:  $a_{x\_in} = 0,6872 \text{ m/sec}^2$ ;
- 2) along the lateral axis:  $a_{y\_in} = 0,6872 \text{ m/sec}^2$ ;
- 3) along the vertical axis:  $a_{z\_in} = 0,8836 \text{ m/sec}^2$ .

Results of the designed SCAS simulation are introduced on fig. 2 –7.

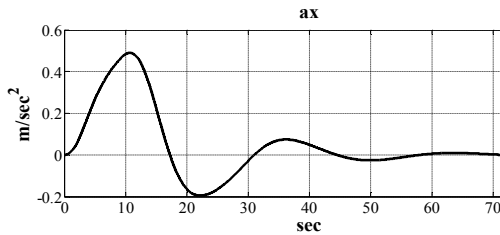

Fig. 2. Longitudinal acceleration  $a_x$  transient process

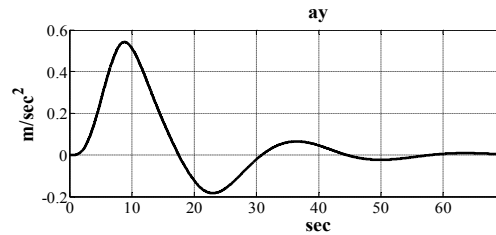

Fig. 3. Lateral acceleration  $a_y$  transient process

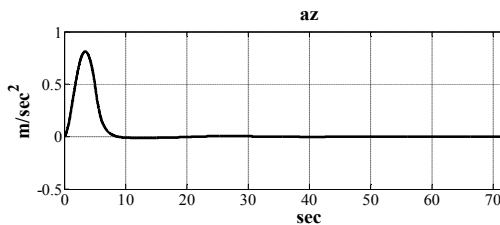

Fig. 4. Vertical acceleration  $a_z$  transient process

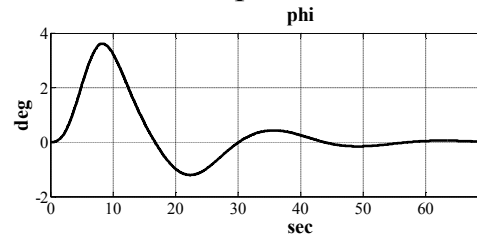

Fig. 5. Roll angle  $\phi$  transient process

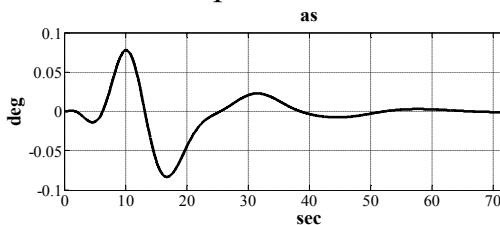

Fig. 6. Flapping angle  $a_s$  transient process

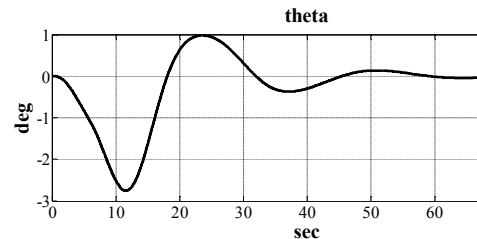

Fig. 7. Pitch angle  $\theta$  transient process

## Conclusions

The introduced LMI- based algorithm allows efficient SCAS design for the RUAV in hover. Designed  $H_2$ -optimal SOF controller feedback controller implementation shows high hovering performance. Small value of spectral norm of the feedback controller unavailable the actuator saturation.

Results of simulation demonstrate rather efficient suppression of BIBO exogenous disturbances of the RUAV in hover via feedback controller application.

## References

1. *Larin V.B.* Stabilization of System by Static Output Feedback// Applied and Computational Mathematics. – 2003. – V. 2. – N 1. – pp. 2 – 12.
2. *Ларин В.Б.* О компенсации внешних возмущений динамической обратной связью по выходной переменной / В.Б. Ларин, А.А. Туник // Прикладная механика. – 2006. – Т. 42. – № 5. – С. 132–144.
3. *Горбатюк О.Д.* Подавление возмущений, действующих на вертолёт в режиме висения, с помощью статической обратной связи по выходу /



- О.Д. Горбатюк, В.Б. Ларин, А.А. Туник // Проблемы управления и информатики. – 2009. – №3. – С. 87–97.
4. *Larin V.B.* Compensation of External Perturbations under Uncertainty // *Int. Appl. Mech.* – 2002. – V. 38. – N 9. – pp. 1145–1151.
  5. *Hess R.A.* Rotorcraft Handling Qualities in Turbulence // *Journal of Guidance, Control and Dynamics.* – 1995. – V 18. – N 1. – pp. 39–45.
  6. *Boyd S.* Linear Matrix Inequalities in System and Control Theory / S. Boyd, L. El Ghaoui, E. Feron, V. Balakrishnan // PA SIAM.– Philadelphia. – 1994. – 416 p.
  7. *Gahinet P.* LMI Control Toolbox User's Guide / P. Gahinet, A. Nemirovski, A. Laub, M. Chilali // The Math Works Inc. – 1995. – 310 p.
  8. *Баландин Д.В.* Синтез оптимальных линейно-квадратичных законов управления на основе линейных матричных неравенств / Д.В. Баландин, М.М. Коган // *Автоматика и телемеханика.* – 2007. – № 3. – С. 3–18.
  9. *David Hynchul Shim.* Control System Design for Rotorcraft-based Unmanned Aerial Vehicles using Time-domain System Identification / David Hynchul Shim, Hyoun Jin Kim, Shankar Sastry // *IEEE Int. Conference on Control Applications.* – 2000. – pp. 808–813.
  10. *Cunha R.* SimModHeli: A Dynamic Simulator for Model-Scale Helicopters/R. Cunha, C. Silvestre// *Institute for Systems and Robotics.* – Portugal. – <http://med.ee.nd.edu/MED11/pdf/papers/t7-069.pdf>. – 2001. – pp. 1 – 6.
  11. *Davison E.J.* The Design of Controllers for the Multivariable Robust Servomechanism Problem Using Parameter Optimization Methods / *E.J. Davison, I.J. Ferguson* // *IEEE Transaction on Automatic Control.* – 1981. – V.AC-26. – N 1. – pp. 93 – 110.